

A

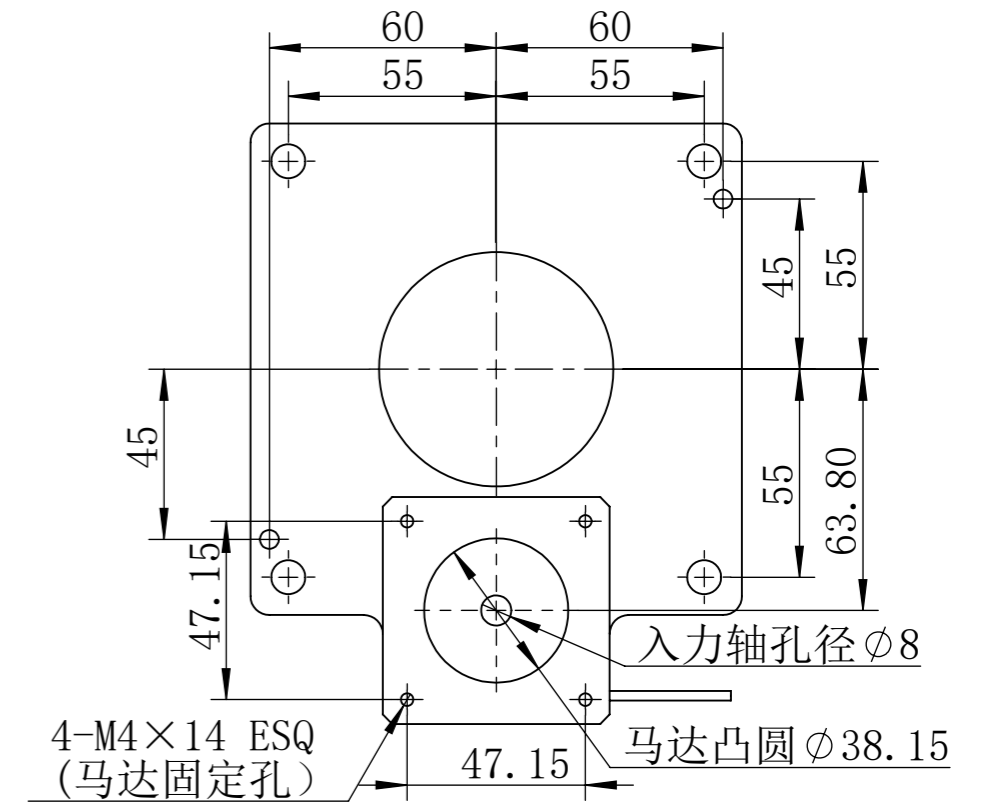

B

C

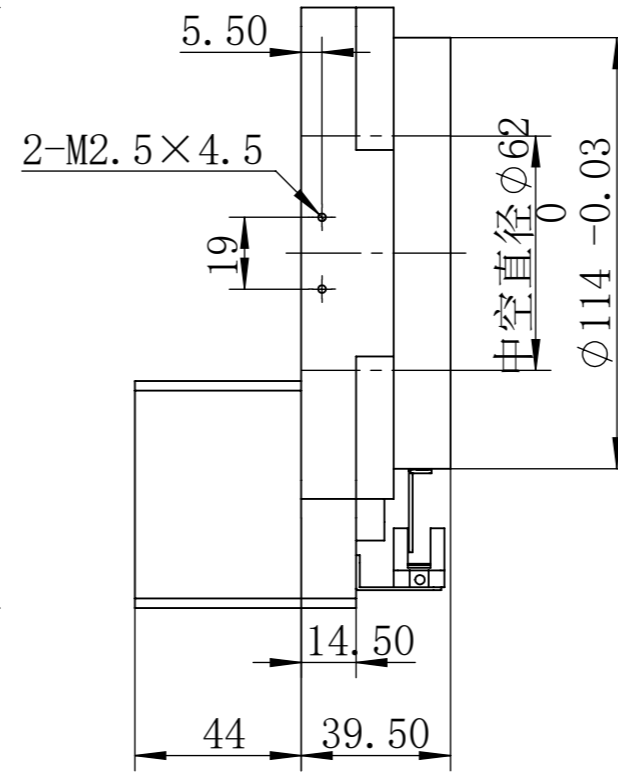
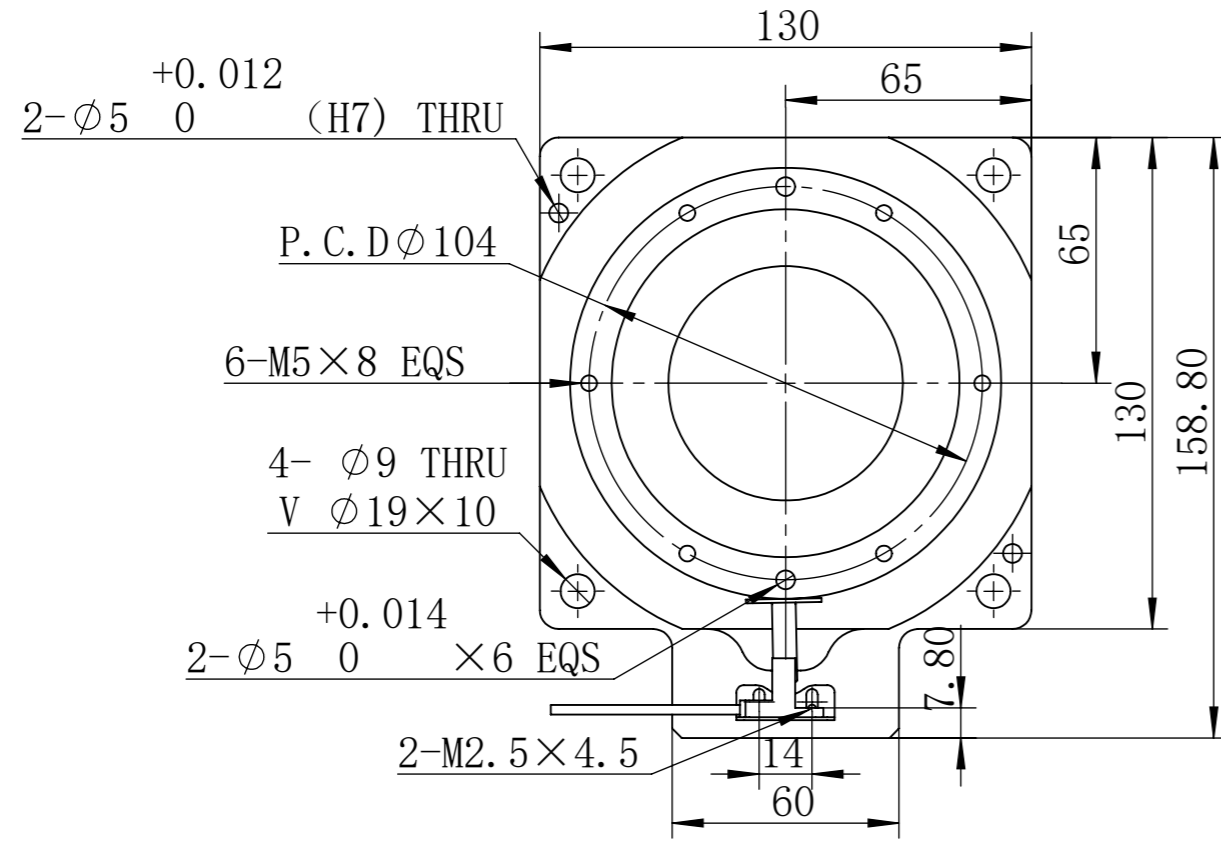
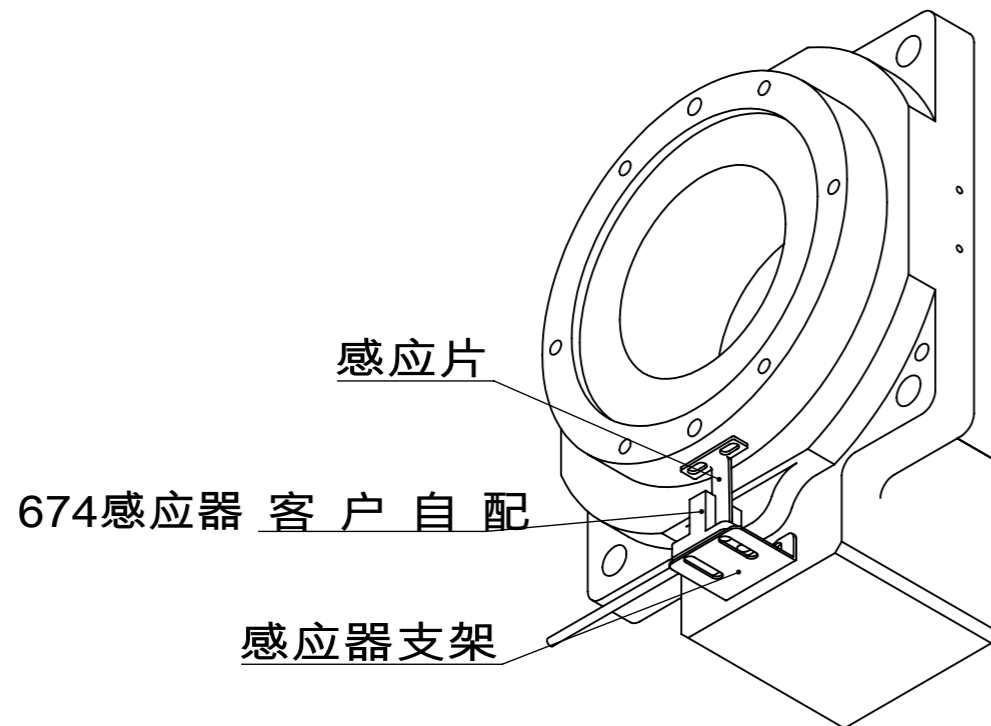

D

技术参数	规格型号		
		ARN130-10k 8-37.15-47.15- M4(57步进)	
旋转平台轴承	交叉滚子轴承		
减速比 i	1 : 10	容许轴向负载 N.m	2500
容许转矩 N.m	55	旋转平台平面度 mm	0.01
容许盘面转速 rpm	200	旋转平台同心度 mm	0.01
重复定位精度 arc-sec	10	精度寿命 hr	20000(间歇运转)
定位精度 arc-sec	±30	保护等级 IP	40